

# Complex Images

for ALL Learners

## A GUIDE TO MAKE VISUAL CONTENT ACCESSIBLE



This project is part of my research during my last year of a master's degree in Instructional Design and Technology at Western Illinois University. It is inspired by several great and informative resources from [Diagram Center](#), [NCAM-National Center for Accessible Media](#), [W3C](#), [WebAIM](#), [DO-IT University of Washington](#), [PENN State University](#), and [APH - American Printing House](#). I authorize publication of this handbook on PCC's Accessibility website as an Open Educational Resources through Creative Commons.

Supada Amornchat





# Table of Contents

- I. Introduction.....2
- II. Alternate Formats(Alt).....3
  - A. Text Descriptions..... 4
  - B. Lists..... 5
  - C. Data Table..... 6
  - D. Tactile Graphics..... 7
- III. Types of Tactile Graphics.....8
  - A. Pie Charts.....9
  - B. Bar Charts..... 11
  - C. Line Graphs..... 13
  - D. Flowcharts ..... 15
  - E. Diagram Charts ..... 17
  - F. Illustrations..... 19
  - G. Math & Graphs..... 21
  - H. Maps..... 23
- IV. Other Types of Alt Formats ..... 25
- V. Conclusion..... 27
- VI. Glossary..... 28
- VII. Resources..... 29
- VIII. References..... 30
- IX. Acknowledgements..... **Back Cover**



# I. Introduction

## WHAT ARE COMPLEX IMAGES?

**Complex images** refer to substantial information that may be challenging to describe in a short phrase or sentence. Learners may not understand the images without a long description.

Making complex images accessible for everyone can be challenging. It involves understanding the purpose, the content itself, the audiences, and the technology to create and access alternative formats.

**Examples of complex images:** pie charts, bar charts, line graphs, flowcharts, diagrams, illustrations, math graphs, and maps.

## WHY DO COMPLEX IMAGES MATTER?

**“A picture is worth a thousand words.”**

A complex idea can be conveyed visually with just a single image for sighted people. However, without alternate formats, people with a visual impairment cannot access that content.

## HOW CAN I MAKE COMPLEX IMAGES ACCESSIBLE?

Because there is a limit to how many characters fit in an alternative text description attribute (approx. 100), complex images need alternative text options that allow for longer descriptions. It is necessary to describe complex images meaningfully. There are three methods to display a long text description of the image accessibly: 1) using a caption, 2) describing the image in surrounding text, and 3) linking out to a web page.



## II. Alternative Formats (Alt)

### WHAT IS ALT FORMAT?

There is no one format type that meets the needs of all students. Which Alt format works best depends on the types of complex images.

#### A Text Description

Text description is the most common format that benefits learners broadly. Describe concisely, clearly, and meaningfully. Unnecessary words may confuse learners.

**Figure:** The bar graph compares rates of poverty between American males and females over 65 in 2006.

#### B Lists

Convert flowcharts and bar graph data into lists: numbered lists for procedures & bulleted lists for items without a sequence.

- **Poverty rate for working full-time**
  - Males 1.8%
  - Females 2.1%
- **Poverty rate for working part-time**
  - Males 2.3%
  - Females 2.9%
- **Poverty rate for not working**
  - Males 8.1%
  - Females 13.2%

#### C Data Tables

Present in correct reading order: from left to right and top to bottom. Include table caption and column/row headers.

**Yearly expenses and profits**

Poverty Rate	Male	Female
Working full-time	1.8%	2.1%
Working part-time	2.3%	2.9%
Not working	8.1%	13.2%

#### D Tactile Graphics

Tactile graphics are designed to deliver image content through touch. They associate tactile symbols & [braille](#).



## A. Text Descriptions

### WHAT TO DESCRIBE

It is important that describers have knowledge in the subject area they describe. Questions to consider:

- What are the content and the purpose of the image?
- What is the main focus in the image?
- Who is the target audience, novice or expert?
- Make sure to include any text that is displayed in the image.

### HOW TO DESCRIBE

There is no exact rule of how to describe complex images. It depends on what you are trying to convey. These are some guidelines for writing effective image descriptions.

- Write clear, concise, and accurate descriptions.
- Describe ideas from general to specific.
- Use words rather than symbols when writing scientific or mathematical expressions.
- Present information consistently and in its logical order.
- If the image contains a lot of data information, present data separately from description of the overall image.
- Focus on the key information rather than extraneous visual elements.
- Describe images using basic 5Ws (Who, What, Where, When, and Why).

### WHEN TO USE TEXT DESCRIPTION

It is always best to include text description when you are publicly posting your information or you are not sure if your audience may include someone with a visual impairment.



# B. Lists

## WHEN TO USE LISTS

Bulleted/numbered lists are an accessible format to show relationships between each element such as ideas, activities, and their connection in a broad scope. Bulleted lists are commonly used for structured outlines while numbered lists represent procedure or process. Four types of complex images can be transformed to lists:

- Pie charts
- Bar charts (horizontal and vertical)
- Line graphs
- Flowcharts (hierarchy/tree diagram)

## HOW TO TRANSFORM COMPLEX IMAGES TO LISTS

When converting complex images to lists, include a brief description and a summary of the images. This will introduce the concept to the students and what they should expect (See more examples from Diagram Center - <http://bit.ly/2r2U9wr>).

**Example:**

**Pie chart**

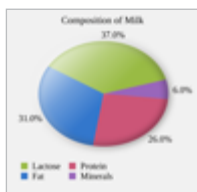

- Composition of milk
- Lactose 37%
  - Fat 31%
  - Protein 26%
  - Minerals 6%

**BAR CHART**



- Employment of disabled vs. non-disabled Americans
- In 1991:
    - Non-disabled is 84.4%
    - Disabled is 50.2%
  - In 2010:
    - Non-disabled is 79.1%
    - Disabled is 41.1%

**LINE GRAPH**

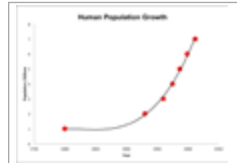

- The growth of human population from the mid-1800s
- In 1800 - 1 billion
  - In 1930 - 2 billion
  - In 1970 - 3 billion
  - In 2000 - 6 billion
  - In 2007 - 7 billion

**FLOWCHART**



- How to order food
1. Start
  2. Order burger
  3. Want fries?
    - If yes, order fries
  4. Want drink?
    - If yes, order drink
  5. Pay cashier



# C. Data Table

## WHEN TO USE DATA TABLES

There are 4 types of complex images that can be converted to data tables:

- Pie charts are good when showing percentage or proportional data.
- Bar charts are used to compare data among categories.
- Line graphs are used to compare changes over the period of time.
- Complex tables can be broken into separate tables.

## HOW TO CONVERT IMAGES TO DATA TABLE

**Key:** Analyze the categories and objects from the graphs/charts & transfer to table columns/rows. Include a table caption & column/row headers.

**PIE CHART**

List the numbers from smallest to largest.

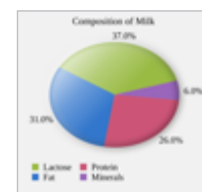

Composition	%
Minerals	6
Protein	26
Fat	31
Lactose	37

**BAR CHART**

Briefly describe the chart & a summary, and provide title and axis labels.

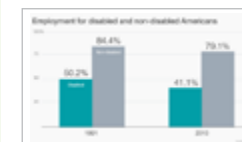

Year	Non-disabled	Disabled
1991	84.4%	50.2%
2010	79.1%	41.1%

**LINE GRAPH**

List the numbers from earliest to latest year.

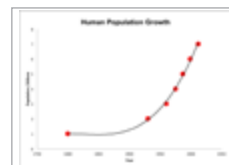

Year	Population
1800	1 billion
1930	2 billion
1970	3 billion
2007	7 billion

**COMPLEX TABLE**

Data separated into 3 tables aids cognitive overload in navigation.

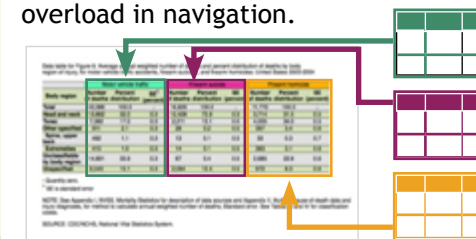



## D. Tactile Graphics

### WHEN TO USE TACTILE GRAPHICS

Tactile graphics are for low vision and blind users, who perceive visual information by touching through lines, textures, and braille text. Images like maps, charts, and diagrams can be converted to a tactile graphic format. So when should we use a tactile graphic?

- When a student needs to learn how to read images
- When the image cannot be understood by describing in text format

### WHAT TO CONSIDER

Not all images can be converted to tactile graphics. There are some limits. Below is a guideline for tactile graphics:

- Keep it simple. Too much information may become a barrier to learning.
- Eliminate extraneous parts of the diagram (i.e., irrelevant information).
- Edit/proofread with your fingers, not your eyes.
- Make it clear and concise.
- Determine the original shapes and textures. Are they necessary to convey the concept or can the geometric shapes be simplified?
- Determine if the image requires accurate measurements and scaling, and if the original shapes, textures and total image are necessary to convey the concept.
- Use language that is appropriate to the student's age, knowledge level, and skill.



## III. Types of Complex Images

### A PIE Charts | P-9

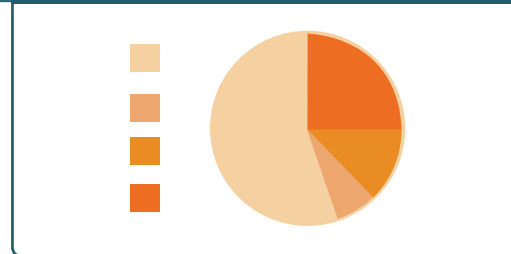

### B BAR Charts | P-11

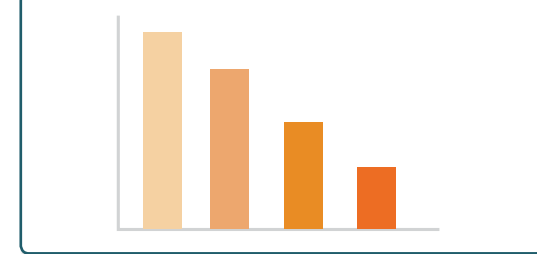

### C LINE Graphs | P-13



### D Flowcharts | P-15

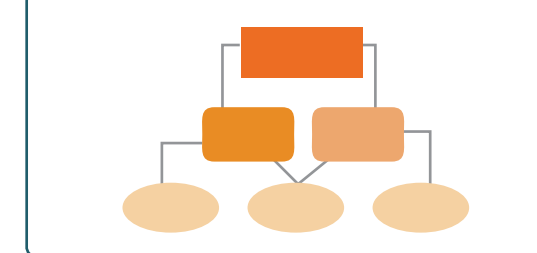

### E DIAGRAM Charts | P-17

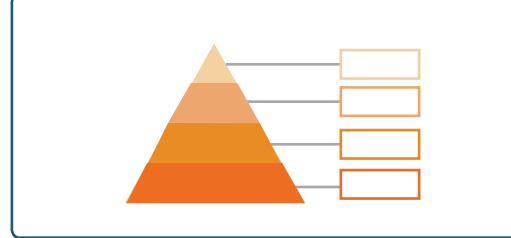

### F Illustrations | P-19

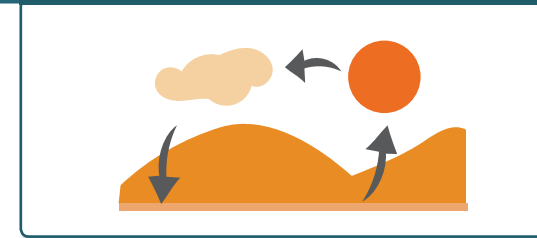

### G MATH & Graphs | P-21

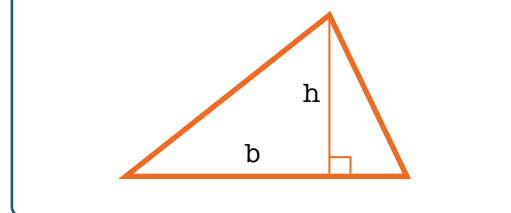

### H Maps | P-23

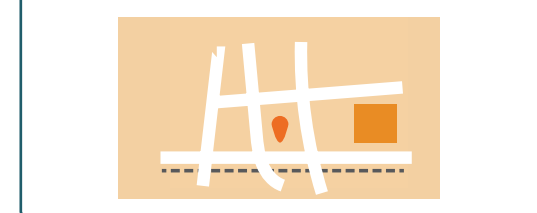

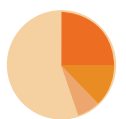

# A. PIE Charts

## HOW TO MAKE PIE CHARTS ACCESSIBLE?

### EXAMPLE

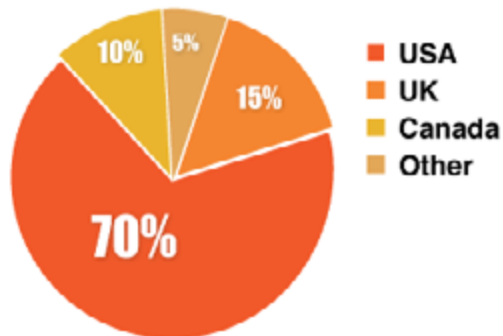

Figure 8A: The pie chart shows the percentage of non-native English speakers in the major English-speaking countries of the world from 2000 - 2002.

### GUIDELINES FOR DESCRIPTIONS

- Alternative text should not use the phrases “image of...” or “graphic of...,” or be redundant (use the same description as the body text).
- It’s not necessary to describe the visual attributes of the charts (i.e., orange wedge, gray lines) unless it is an exam question that refers to these attributes.
- List numbers from largest to smallest regardless of how they are presented in the image.

## THREE OPTIONS TO MAKE ALTERNATIVE FORMATS

### 1. TEXT Description & List

The pie chart shows the percentage of non-native English speakers in the major English-speaking countries of the world from 2000 to 2002.

- 70% from United States
- 15% from United Kingdom
- 10% from Canada
- 5% from other countries

### 2. DATA Table

The pie chart can also be presented in a table data format. Figure 8A is a pie chart that illustrates the percentage of non-native English speakers in the major English-speaking countries of the world from 2000 to 2002.

Non-native English speakers in English speaking countries

Country	Percentage of Total
United States	70%
United Kingdom	15%
Canada	10%
Other countries	5%

### 3. TACTILE Graphic

#### EXAMPLE

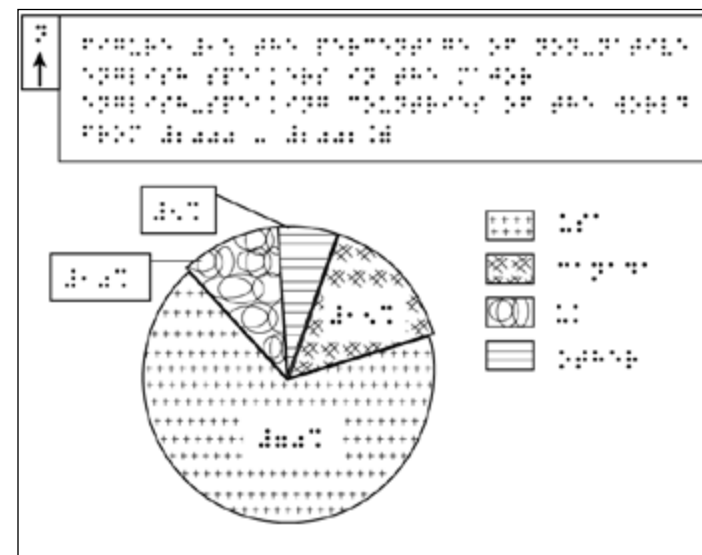
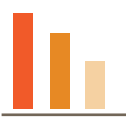

Figure 8B: A tactile graphic converted from figure 8A.

- **Colors:** Use texture patterns that can be easily distinguished by touch.
- **Lines:** Use thick lines (at least 2 pt.) to divide sections.
- **Keys:** (1) Place the key and the graph on the same page; (2) List the sections in clockwise order, starting from the top.
- **Arrows:** Use arrows to indicate direction.



## B. BAR Charts

### HOW TO MAKE BAR CHARTS ACCESSIBLE?

#### EXAMPLE

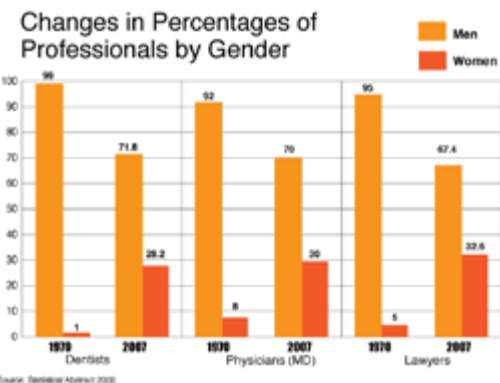

**Figure 9A:** This chart depicts the change in the percentage of men and women in three professional occupations (dentist, physician, lawyer), from 1970 to 2007.

#### GUIDELINES FOR DESCRIPTIONS

- Provide the title and the x- and y-axis labels.
- Briefly describe the graph. What does the graph measure?
- Explain the data on the x-axis and the y-axis and summarize the overall trend.
- It is not necessary to describe the visual attributes of the bars (e.g., light brown, orange) unless it is part of an exam question.
- Convert data to an accessible table or a bulleted list.

### THREE OPTIONS TO MAKE ALTERNATIVE FORMATS

#### 1. TEXT Description

**Figure 9A** is a bar chart that illustrates the change in percentage of men and women who work in three professional occupations: dentists, physicians, and lawyers in U.S. between 1970 and 2007. Men working in all of these professions decreased from 1970 to 2007, while women working in all three professional careers dramatically increased.

- Dentists: Men 99% (1970), 71.8% (2007); Women 1% (1970), 28.2% (2007)
- Physicians: Men 92% (1970), 70% (2007); Women 8% (1970), 30% (2007)
- Lawyers: Men 95%(1970), 67.4% (2007); Women 5% (1970), 32.6% (2007)

#### 2. DATA Table

**Figure 9A** can be converted to a data table format as shown.

The percentage of men and women who worked in three professional careers between 1970 to 2007

x-axis: professions  
y-axis: percentage

Professions	1970	2007
Dentists	Men 99% Women 1%	Men 71.8% Women 28.2%
Physicians (MD)	Men 92% Women 8%	Men 70% Women 30%
Lawyers	Men 95% Women 5%	Men 67.4% Women 32.6%

#### 3. TACTILE Graphic

#### EXAMPLE

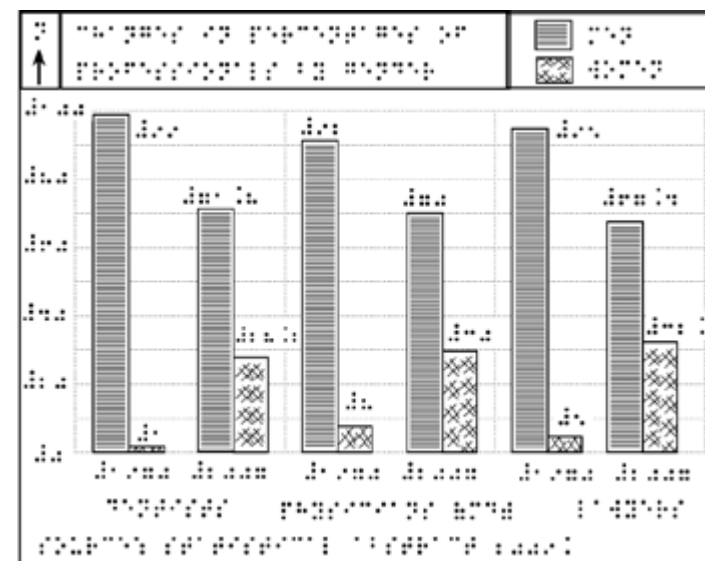

**Figure 9B:** A tactile graphic converted from figure 9A.

- **Orientation:** Make sure to match the original.
- **Grid:** Use dotted grid lines to track and distinguish the values from the bars.
- **Label:** Indicate x-axis & y-axis labels.
- **Texture:** Use the texture patterns that are distinctive enough for each category.
- **Label:** Include heading labels and directional arrow at the top of the page.



# C. LINE Graphs

## HOW TO MAKE LINE GRAPHS ACCESSIBLE?

### EXAMPLE

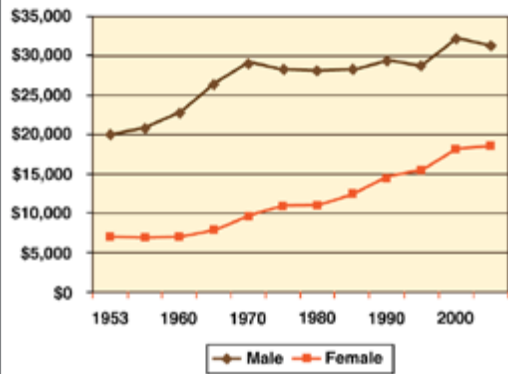

Figure 10A: Income of men and women from 1953 to 2005.

### GUIDELINES FOR DESCRIPTIONS

- Line graphs can be converted into accessible data tables.
- Give a brief overview & summarize data.
- Provide the title and axis labels.
- No need to describe the visual attributes of the graph (dashed, solid lines) unless it is required for an assessment.
- Include data in details using bulleted lists or a data table format.

## THREE OPTIONS TO MAKE ALTERNATIVE FORMATS

### 1. TEXT Description

Figure 10A: Income of men and women from 1953 to 2005.

This line graph shows the comparison between men’s and women’s income from 1953 to 2005. The y-axis shows the amount of income in dollars from \$0 to \$35k with \$5k increments. The x-axis represents years from 1953 to 2005 with ten year increments. In the graph, the men’s line begins in 1953 at \$20k dollars, and rises steeply in 1970 to \$29k, then it begins to level out until the year 2000 (except for a slight dip in 1995) when it rises to \$32k, but then takes another slight dip in 2005. For the women’s line, the income begins in 1953 at \$7k and rises steadily to \$18k until 2005.

### 2. DATA Table

Figure 10A: The data is summarized in the following data table.

Year	Men’s income (dollars)	Women’s income (dollars)
1953	\$20,000	\$7,000
1960	\$23,000	\$7,200
1970	\$29,000	\$10,000
1980	\$28,000	\$10,500
1990	\$29,500	\$15,000
2000	\$32,000	\$18,000
2005	\$31,000	\$19,000

### 3. TACTILE Graphic

#### EXAMPLE

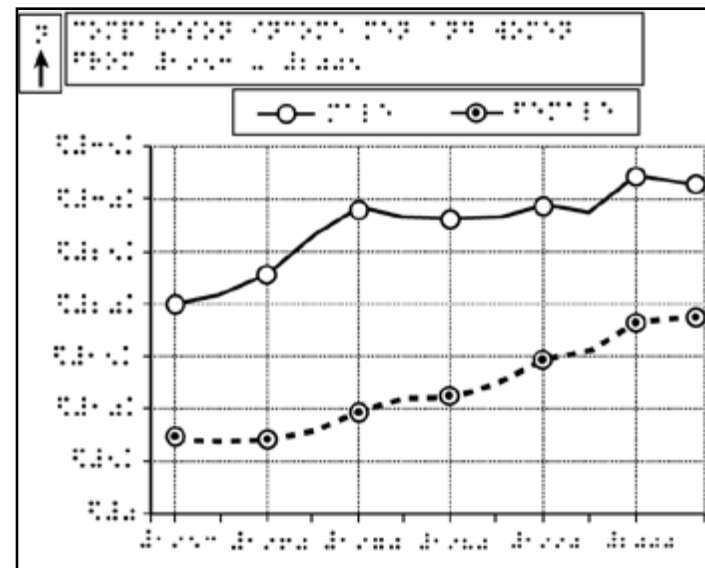

Figure 10B: A tactile graphic converted from figure 10A.

- **Numbers:** Use the number sign (#) if the values are numeric.
- **Grid:** Add grid lines when the values need to be tracked even if not shown in original.
- **Lines:** The x-axis (horizontal) & y-axis (vertical) lines must be distinctive and bolder than grid lines.
- **Key:** Place the key before the graph on the same page.





## D. Flowcharts

### HOW TO MAKE FLOWCHARTS ACCESSIBLE?

#### EXAMPLE



Figure 11A: The flowchart depicts the process of sending an e-mail in Microsoft Outlook.

#### GUIDELINES FOR DESCRIPTIONS

- Begin with a brief overview, describing the distinct elements of the image, including if it has multiple starting points, lists, etc.
- Simple flowcharts can be converted into nested lists with good results. Present the “shapes” as numbers and the possible transitions as sub-bullets.
- Approach the diagram from top to bottom and from left to right.
- Combining description with a tactile version of a flowchart may provide increased access.
- Include a description if it is two-way directional arrow.

### THREE OPTIONS TO MAKE ALTERNATIVE FORMATS

#### 1. TEXT Description

The flowchart shows the process of sending an email in Microsoft Outlook. There are eleven labeled boxes connected to each other by arrows pointing in the same direction. At the starting point in the flowchart & in the process, press the New (email) button. The next point is a decision point, “Is the email address of the receiver in your address book?” If yes, proceed to option 1, & if no, proceed to option 2. At the end of option 1, the two processes merge back together.

#### 2. LIST

Generally, flowcharts show how steps in a process fit together. They can be converted into a list format.

1. Press the **New** button
2. Is the e-mail address of the receiver in your address book?
  - a. **Yes** (Go to step 3)
  - b. **No** (Go to step 6)
3. Click the **To** button
4. Double click the name of the receiver
5. Click the **OK** button
6. Type the email address of the receiver
7. Click in the **Subject** box
8. Type the **Subject** information
9. Click in the message area
10. Type the message
11. Press **Send** button

#### 3. TACTILE Graphic

#### EXAMPLE

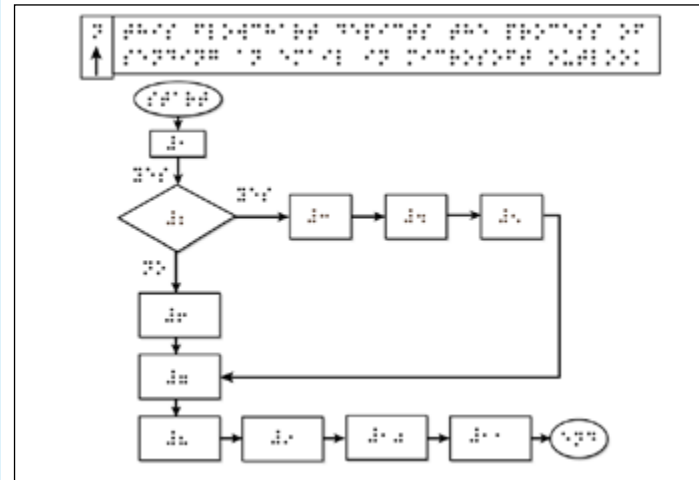

Figure 11B: A tactile graphic converted from figure 11A.

- **Numbers:** Use the number sign (#) if the values are numeric.
- **Combination:** Use a tactile graphic along with the list format.
- **Arrow:** Use an arrow to indicate direction.
- **Label:** Shapes should be labeled with alphabetical or numerical key.
- **Space:** Leave enough room between braille & line.



## E. DIAGRAM Charts

### HOW TO MAKE DIAGRAM CHARTS ACCESSIBLE?

#### EXAMPLE

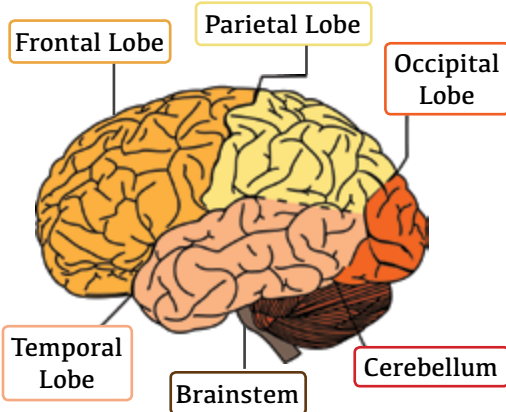

Figure 12A: The side view of human brain anatomy.

#### GUIDELINES FOR DESCRIPTIONS

- Identify the type of image (i.e., graph, diagram, chart).
- Determine the main point of the image. What is the image about?
- Give a brief overview of the image from general to specific details.
- Organize the description in a linear fashion, moving left to right and top to bottom.
- Use bullet points, numbered lists, or break lines to aid in navigation.

### THREE OPTIONS TO MAKE ALTERNATIVE FORMATS

#### 1. TEXT Description

The diagram in Figure 12A shows the anatomy of a human brain. It is divided into six major sections. Starting from the upper left and moving clockwise is the Frontal Lobe, Parietal Lobe, Occipital Lobe, Cerebellum, Brainstem, and Temporal Lobe. (1) **Frontal Lobe** takes about half of the brain. (2) **Parietal Lobe** is in the middle between Frontal Lobe and Occipital Lobe. (3) **Occipital Lobe** is a small part at the back of the brain. (4) **Cerebellum** is the same size as Occipital Lobe and located below it. (5) To the left of Cerebellum is the **Brainstem**, a tip that connects to Temporal Lobe. (6) Lastly, **Temporal Lobe** is the left part of the brain.

#### 2. LIST

From the top left of the image moving clockwise, the human brain consists of:

- Frontal Lobe** - located in the front of the brain
- Parietal Lobe** - located near the center of the brain behind the frontal lobe
- Occipital Lobe** - located in the back area of the brain
- Cerebellum** - located behind the top part of the brain stem (where the spinal cord meets the brain) and is made of two hemispheres (halves)
- Brainstem** - connects the cerebrum with the spinal cord
- Temporal Lobe** - located beneath the frontal and parietal lobes & centered across both cerebral hemispheres of the brain

#### 3. TACTILE Graphic

#### EXAMPLE

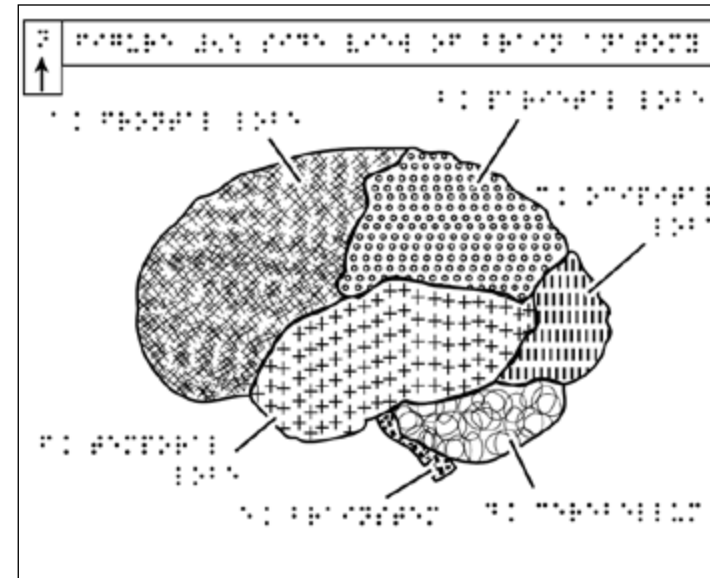

Figure 12B: A tactile graphic converted from figure 12A.

- **Label:** Use numeric or alphabetical key for organization.
- **Arrow:** Place arrow at the top to indicate direction.
- **Texture:** Use various textures that can be easily distinguished by touch.
- **Lines:** Make thick lines to point to labels & thicker lines to indicate boundary.
- **Keys:** If possible, place the keys on the same page and before the graphic.



## F. Illustrations

### HOW TO MAKE ILLUSTRATIONS ACCESSIBLE?

#### EXAMPLE

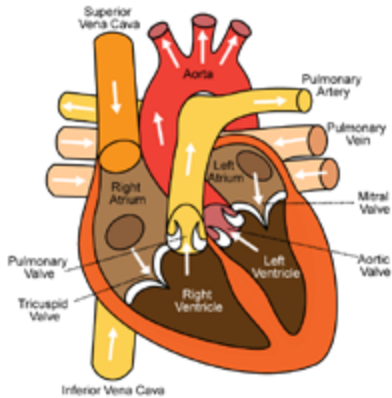

Figure 13A: The front view of the anatomy of cardiac cycle.

#### GUIDELINES FOR DESCRIPTIONS

- For diagrams or illustrations with arrows, describe the arrow's function instead of the arrow itself. Use appropriate phrases, such as "leads to," "points to," "yields," "feeds on," "changes into," depending on the context.
- Use bulleted lists to organize the steps when individual phases are important.
- Use a narrative to tell a story when the general concept is more important.

### THREE OPTIONS TO MAKE ALTERNATIVE FORMATS

#### 1. TEXT Description

This diagram illustrates the anatomy of the cardiac cycle. It shows a cross-section of the heart. Blood enters the heart through the inferior and superior vena cava, emptying oxygen-depleted blood from the body into the right atrium. The blood then travels to the right ventricle and is pumped to the lungs via the pulmonary artery. The pulmonary vein empties oxygen-rich blood from the lungs into the left atrium. This blood is then pumped to the left ventricle and is sent to the systemic circuit via the aorta.

#### 2. LIST

Text descriptions and lists can be used together. Use descriptions to summarize the general concept and use lists for information in more detail.

1. In contraction (*systole*), the heart pumps blood out through the arteries.
2. In relaxation (*diastole*), the heart fills with blood. One complete sequence of filling and pumping blood is called a cardiac cycle.
3. Pressure in the atria exceeds ventricular pressure. The AV valves open and the ventricles fill passively.
4. Atrial contraction forces additional blood into ventricles.
5. Ventricular contraction pushes the AV valves closed and increases pressure inside the ventricle.
6. Increased ventricular pressure forces the semilunar valves open.
7. As the ventricles relax, pressure in the arteries exceeds ventricular pressure, closing the semilunar valves.

#### 3. TACTILE Graphic

#### EXAMPLE

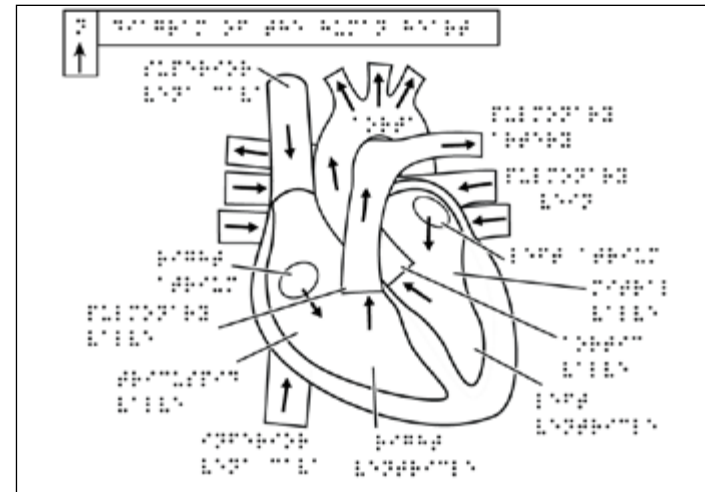
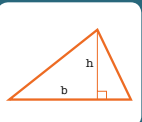

Figure 13B: A tactile graphic converted from figure 13A.

- **Direction:** Use up arrow to indicate compass direction.
- **Lines:** Use thick lines for arrows and for dividing shapes.
- **Arrows:** Use solid triangle as an arrowhead and make the lines thicker than other lines used in the drawing.
- **Label:** Use numbers or letters to indicate an order in the diagram.



# G. MATH & Graphs

## HOW TO MAKE MATH GRAPHS ACCESSIBLE?

### EXAMPLE

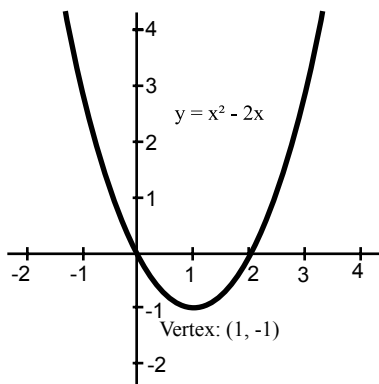

Figure 14A: A line graph shows a formula of  $y = x^2 - 2x$ .

### GUIDELINES FOR DESCRIPTIONS

- State the type of graph and what it is about.
- Describe what the x-and y-axes represent.
- Write out the points in bullet form.
- Include the data points of the figure, the comma between the x- and y-coordinate (i.e. (5, 3)).
- Spell out abbreviated units (ft. = feet).
- Organize the description in a linear orientation from left to right, top to bottom.

## FOUR OPTIONS TO MAKE ALTERNATIVE FORMATS

### 1. TEXT Description & List

Figure 14A: The line graphs shows a parabola curve of the formula of  $y = x^2 - 2x$ . The vertex of the parabola is at (1,-1).

- $x = -2, y = 8$
- $x = -1, y = 3$
- $x = 0, y = 0$  This is an x intercept.
- $x = 1, y = -1$  This is the vertex.
- $x = 2, y = 0$  This is the other x intercept.
- $x = 3, y = 3$

### 2. DATA Table

Figure 14A: The math equation can be reformatted as data table, as follows.

x	$y = x^2 - 2x$
-2	8
-1	3
0	0
1	-1 (Vertex)
2	-1
2	0
3	3

### 3. SONIFICATION

The math equation can be generated as sonification. Click on the **Play** symbol below to play the sonification or go to the quadratic function graph sample from DiagramCenter (<http://diagramcenter.org/sample-book/03b-Quadratic.shtml>)



### 4. TACTILE Graphic

### EXAMPLE

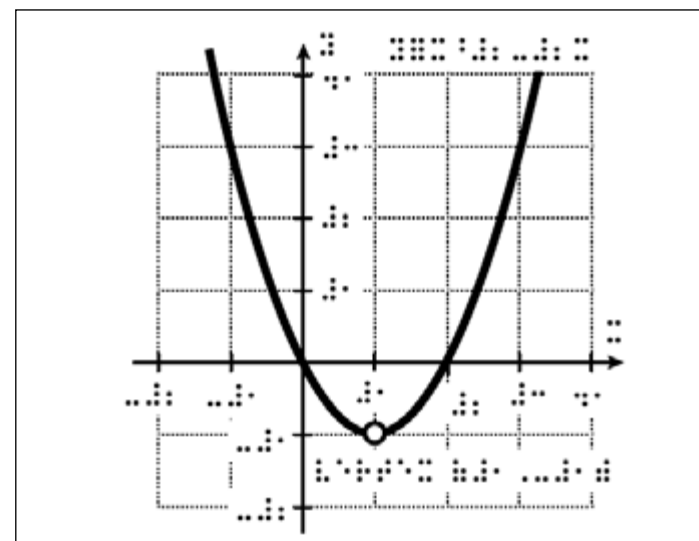

Figure 14B: A tactile graphic converted from figure 14A.

- **Numbers:** Use the number sign if the values are numeric.
- **Grid:** Add grid lines when the values need to be tracked.
- **Lines & Points:** Limit the lines, points, and symbols on a drawing to ones that can be easily identified and distinguished from one another.
- **Texture:** Use texture sparingly and only to add info.



## HOW TO MAKE A MAP ACCESSIBLE?

### EXAMPLE



Figure 15A: Map of the growth of diversity in different states of United States of America from 1990 to 1999.

### GUIDELINES FOR DESCRIPTIONS

- If the map is used to illustrate a concept and help define new terms, describe the lines of latitude and longitude and explain how they look on the map (horizontal, vertical), and the corresponding degrees.
- If the map is used as part of a geography lesson and the land and water are relevant, describe the labeled areas, including their relationship and distance to each other when relevant.

## THREE OPTIONS TO MAKE ALTERNATIVE FORMATS

### 1. TEXT Description

This map illustrates the growth of diversity in different U.S. states from 1990 to 1999. The map color codes each state into four categories depending on the level of increase in Latino, African American and Asian populations in their state.

- Low - 11 states
- Fair - 9 states
- Moderate - 12 states
- High - 11 states

### 2. DATA Table

The growth of diversity in different states in the U.S.

Growth of Diversity	States
Low	Montana, Arizona, Nebraska, Oklahoma, Wisconsin, Louisiana, Tennessee, West Virginia, New Jersey, New Hampshire, Hawaii
Fair	Oregon, Utah, South Dakota, Missouri, Mississippi, Indiana, New York, North Carolina, Alaska
Moderate	Washington, Wyoming, Nevada, New Mexico, Kansas, Minnesota, Illinois, Arkansas, Ohio, Virginia, South Carolina, Alabama
High	California, Idaho, Colorado, North Dakota, Texas, Iowa, Michigan, Kentucky, Georgia, Vermont, Pennsylvania

### 3. TACTILE Graphic

#### EXAMPLE

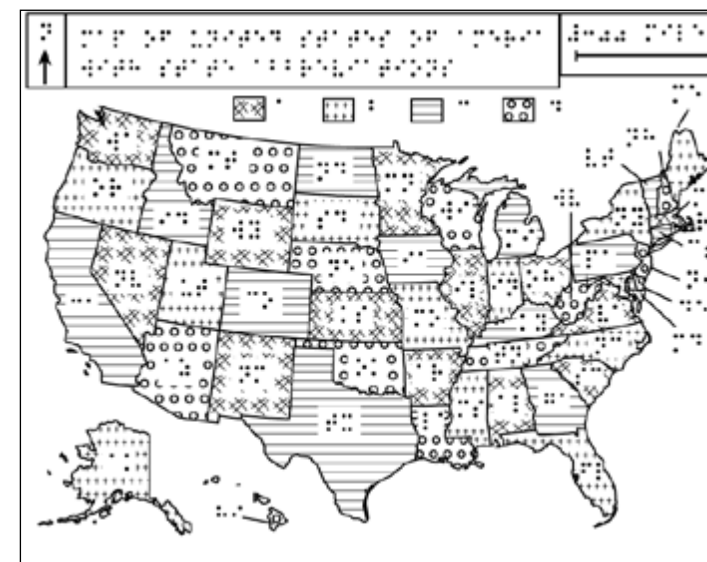

Figure 15B: A tactile graphic converted from figure 15A.

- **Scale:** Place after area, line, & point symbols as part of the key.
- **Labels:** Use acronym to indicate the country.
- **Texture:** Use texture that can be easily distinctive both visually and tactually.
- **Key:** Place the key & the graph at the top on the same page.
- **Lines:** Use thicker lines for borders.



## IV. Other Types of Alt Formats

### A. RECORDED AUDIO

Long text description can be easily converted into a wide variety of audio formats (such as .WAV, .MP3, and .OGA) and can be played from web browsers. Some students learn better by listening to an auditory modality.



**Example:** [Video of Description Explained by CaptionMax \(1:34\)](https://youtu.be/BfGYV7dHlbY) (<https://youtu.be/BfGYV7dHlbY>)

### B. SONIFICATIONS

**Sonification** (<https://en.wikipedia.org/wiki/Sonification>) is another way of converting mathematic data to non-speech audio using temporal, spatial, amplitude, and frequency. Blind users perceive information by listening to an increase or decrease in sound pitch or amplitude.

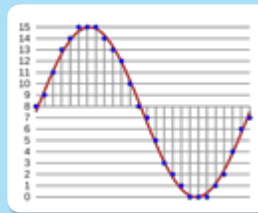

**Example:** [2 seconds of 220 Hz. Sine Wave sonification](https://en.wikipedia.org/wiki/File:220_Hz_sine_wave.ogg) ([https://en.wikipedia.org/wiki/File:220\\_Hz\\_sine\\_wave.ogg](https://en.wikipedia.org/wiki/File:220_Hz_sine_wave.ogg))

### C. SCALABLE VECTOR GRAPHICS (SVG)

**SVG** ([https://en.wikipedia.org/wiki/Scalable\\_Vector\\_Graphics](https://en.wikipedia.org/wiki/Scalable_Vector_Graphics)) is an XML-based vector image format that helps visually impaired users read graphics. It contains accessibility features, such as graphic scalability and interactivity. It can be enlarged without losing the image quality and takes up less storage space compared to raster images.



## Other Types of Alt Formats (cont.)

### D. EPUB

**EPUB** (<https://en.wikipedia.org/wiki/EPUB>) is an e-book file format that can be downloaded and read on various devices, such as smartphones, tablets, computers, or e-readers. It requires an application to open the .epub file. There are many free apps you can install on your computer and use, such as [EPUB File Reader](#), [Kindle \(Amazon\)](#), [iBooks \(Mac\)](#), [MagicScroll](#) (Chrome).



### E. 3D PRINTING

**3D printing** ([https://en.wikipedia.org/wiki/3D\\_printing](https://en.wikipedia.org/wiki/3D_printing)) is a process of making a physical object from a three-dimensional digital model, typically by laying down many successive thin layers of a material. 3D printed items can be customized.

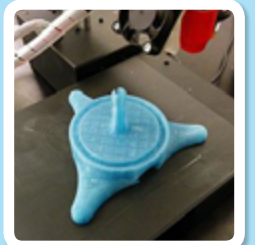

**Video:** [How 3D printing helps the blind 'see' art](https://usat.ly/2qtoEi2) (<https://usat.ly/2qtoEi2>).

### F. HAPTIC TECHNOLOGY

**A Haptic device** (<http://bit.ly/1ZQG7u8>) can aid computer users who are visually impaired by providing a slight resistance at the edges of windows and buttons so that the user can “feel” the [Graphical User Interface \(GUI\)](#) (<http://bit.ly/1Bl5fAz>) This technology can also provide resistance to textures in computer images which enables computer users to “feel” pictures such as maps and drawings.





## V. Conclusion

### SUMMARY

I hope this handbook can be helpful to make complex images accessible to all learners. This handbook includes:

- An overview of complex images
- 4 common types of alternative formats and others
- 3 ways of providing long text descriptions
- 8 types of complex images
- Guidelines for writing meaningful image descriptions with examples
- Guidelines for creating tactile graphics for different types of complex images with examples
- A brief introduction to different types of alternative formats

### LOOKING AHEAD

The discipline of making complex images accessible is vast and innovative. Technology is the driving engine. Developers and users must work together to support inclusive learning while keeping costs down. Graphics need to expand to utilize multiple sensations (e.g., 3D prints to touch, sonification to hear, haptic technology to feel, and Scalable Vector Graphics (SVG) to resize without losing image quality). These technologies make what seems impossible become possible for any learner.

The future of complex graphics is bright and moving forward. As accessibility of interactive functionality and compatibility with modern browsers improves, it will allow anyone to succeed, whether they have a disability or a different learning style.



## VI. Glossary

**3D PRINTING:** makes a physical object from a three-dimensional digital model, typically by laying down many successive thin layers of a material.

**ALTERNATIVE FORMATS:** include audio, braille, electronic or large print versions of standard print such as educational materials, textbooks, information leaflets, and even people's personal bills and letters.

**ASSISTIVE TECHNOLOGY (AT):** is any item or piece of equipment that is used to increase, maintain, or improve the functional capabilities of individuals with disabilities in all aspects of life, including at school, at work, at home, and in the community.

**DATA TABLE:** provides a way to view and compare the results of all the different variations together on your worksheet.

**LONGDESC ATTRIBUTE:** points to a web page that provides a longer, detailed description of an image. When a description is longer than what feasibly works within alt text, longdesc is recommended. The primary reason for its use is for blind and low-vision users who are using a screen reader and cannot see a content-heavy image.

**HAPTIC TECHNOLOGY:** is the science of applying touch (tactile) sensation and control to interact with computer applications.

**Scalable Vector Graphic (SVG):** is used to define vector-based graphics for the web. It defines the graphics in XML format. SVG graphics do NOT lose any quality when they are zoomed or resized. Every element and every attribute in SVG files can be animated.

**SONIFICATION:** uses non-speech audio to convey information or perceptualize data. Auditory perception has advantages in temporal, spatial, amplitude, and frequency resolution that opens possibilities as an alternative format or as a complement to visualization techniques.



## VII. Resources

### IMAGE DESCRIPTION RESOURCES

- [Diagram Center Guidelines](http://bit.ly/2jnC5eO) .....<http://bit.ly/2jnC5eO>
- [WGBH NCAM Complex Images Guidelines](http://bit.ly/1mIDA09).....<http://bit.ly/1mIDA09>
- [W3C: Complex Images Guidelines](http://bit.ly/1OICK6z)..... <http://bit.ly/1OICK6z>
- [PENN State: Complex Images](http://bit.ly/1qerJyl) ..... <http://bit.ly/1qerJyl>
- [How to Write Short Text Descriptions](http://bit.ly/2kqoUHB)..... <http://bit.ly/2kqoUHB>
- [WebAIM: Alternative Text](http://bit.ly/11UHtT4) ..... <http://bit.ly/11UHtT4>
- [APH: Tactile Graphic Image Library](http://bit.ly/2k0YrZi) ..... <http://bit.ly/2k0YrZi>
- [APH: Guidelines for Design of Tactile Graphics](http://bit.ly/2jWIGgS) ..<http://bit.ly/2jWIGgS>
- [Accessible Chemical Diagrams](http://bit.ly/2k0ENrH) ..... <http://bit.ly/2k0ENrH>
- [Guidelines: Describing Images for Assessments](http://bit.ly/2juIQsO)...<http://bit.ly/2juIQsO>

### ASSISTIVE TECHNOLOGY RESOURCES

- [How Blind People Use the Web](http://bit.ly/1t5ngKB)..... <http://bit.ly/1t5ngKB>
- [Five Amazing Gadgets that Help the Blind See](http://bit.ly/1AW5zSk).. <http://bit.ly/1AW5zSk>
- [APH: Blindness Basics](http://bit.ly/2jPaG4b) ..... <http://bit.ly/2jPaG4b>
- [How Does a Blind Man Paint?](http://bit.ly/2jv4ugw)..... <http://bit.ly/2jv4ugw>
- [How the Blind Draw from Art Beyond Sight](http://bit.ly/2jXlpvs)..... <http://bit.ly/2jXlpvs>
- [Technologies for the Blind](http://bit.ly/2kgrL6C) ..... <http://bit.ly/2kgrL6C>
- [List of Screen Readers](http://bit.ly/2kqEyCO)..... <http://bit.ly/2kqEyCO>



## VIII. References

### TACTILE GRAPHIC FILES

The following files are available to download as a single zip file at [samornchat.com/downloads](http://samornchat.com/downloads).

- **Figure 8B:** Pie Chart
- **Figure 9B:** Bar Chart
- **Figure 10B:** Line Graph
- **Figure 11B:** Flowchart shows a process of sending an email in Microsoft Outlook
- **Figure 12B:** A diagram of human brain anatomy
- **Figure 13B:** A diagram of cardiac cycle
- **Figure 14B:** Quadratic function
- **Figure 15B:** U.S. Map

### IMAGE CREDITS

- **Page 2** (St. John Bridge), **6** (bottom), **7** (bottom), **8** (bottom), **11**, **17**, **19**, **23**, **25** (all), and **26** (all) from Wikimedia Commons (<https://commons.wikimedia.org>)
- **Page 6 (Top)** from Statistics Canada (<http://www.statcan.gc.ca/pub/12-581-x/2010000/pop-eng.htm>)
- **Page 7 (Top)** from <http://philschatz.com/anatomy-book/contents/m46416.html>

### AUDIO CREDITS

- **Page 22:** Sonification: *Accessible Image Sample Book* by the Diagram Content Working Group. Retrieved 13 May 2015 from <http://diagramcenter.org/standards-and-practices/accessible-image-sample-book.html>.





## IX. Acknowledgments

### THANK YOU!!!

This Complex Images for All Learners handbook came to me as an inspiration after attending several conferences and webinars, as well as, through discussions with my colleagues in a variety of accessibility groups. This handbook's purpose is as a resource for Portland Community College (PCC) online faculty to help them understand how complex visual content can be accessible for students with visual impairments and blindness.

I would like to acknowledge the magnificent support from Distance Education, the accessibility team, and Disability Services at PCC. Special thanks to my dear colleagues, Katie Davis, Karen Sorensen, and Melany Budiman, who helped with proofreading.

Finally, this handbook was created as part of a portfolio during my master's degree in Instructional Design and Technology, Western Illinois University. This project would not be complete without grateful thanks to my professional chair committee, Dr. James West and Dr. Leanda Hemphill, for their expertise and generous advice.

### CONTACT

I hope this handbook gives you useful guidance to make visuals accessible for everyone. Any feedback, recommendations, or questions about this material will help me improve the handbook. Please contact [supada.amornchat@pcc.edu](mailto:supada.amornchat@pcc.edu).

#### Booklet Design & Style

This booklet was created with Adobe Design, with primary text in Trebuchet MS, 12pt. The page number line is also a tracking device to tell the reader where they are within the whole booklet.

This is the end of the handbook.



Design and develop by Supada Amornchat. It is licensed under CC BY-NC-SA 4.0  
[A link back to [pcc.edu/access](https://pcc.edu/access) would be appreciated.]

